



MODEL: L16RE-2V
DIMENSIONS: inches (mm)
BATTERY: Flooded/wet lead-acid battery
COLOR: Maroon (case/cover)
MATERIAL: Polypropylene

PRODUCT SPECIFICATION

BCI GROUP SIZE	TYPE	CAPACITY ^A Amp-Hours (AH)								ENERGY (kWh)	VOLTAGE	DIMENSIONS ^B Inches (mm)			WEIGHT lbs. (kg)
		2-Hr Rate	5-Hr Rate	10-Hr Rate	20-Hr Rate	48-Hr Rate	72-Hr Rate	100-Hr Rate	100-Hr Rate			Length	Width	Height ^C	
DEEP-CYCLE BATTERY															
903	L16RE-2V	722	909	1021	1110	1182	1210	1235	2.47	2	11-5/8 (295)	7 (178)	17-11/16 (450)	119 (54)	

A. The amount of amp-hours (AH) a battery can deliver when discharged at a constant rate at 80°F (27°C) and maintain a voltage above 1.75 V/cell. Capacities are based on nominal performance.

B. Dimensions are based on nominal size. Dimensions may vary depending on type of handle or terminal.

C. Dimensions taken from bottom of the battery to the highest point on the battery. Heights may vary depending on type of terminal.

Trojan's battery testing procedures adhere to both BCI and IEC test standards.

CHARGING INSTRUCTIONS

CHARGER VOLTAGE SETTINGS (AT 77°F/25°C)	
	Voltage per cell
Absorption charge	2.35-2.45
Float charge	2.20
Equalize charge	2.58

Do not install or charge batteries in a sealed or non-ventilated compartment. Constant under or overcharging will damage the battery and shorten its life as with any battery.

OPERATIONAL DATA

Operating Temperature	Self Discharge	Specific Gravity
-4°F to 113°F (-20°C to +45°C). At temperatures below 32°F (0°C) maintain a state of charge greater than 60%.	Up to 4% per week	The specific gravity at 100% state-of-charge is 1.280

CHARGING TEMPERATURE COMPENSATION

To the Voltage Reading -- Subtract 0.005 volt per cell (VPC) for every 1°C above 25°C or add 0.005 volt per cell for every 1°C below 25°C.

EXPECTED LIFE VS. TEMPERATURE

Chemical reactions internal to the battery are driven by voltage and temperature. The higher the battery temperature, the faster chemical reactions will occur. While higher temperatures can provide improved discharge performance the increased rate of chemical reactions will result in a corresponding loss of battery life. As a rule of thumb, for every 10°C increase in temperature the reaction rate doubles. Thus, a month of operation at 35°C is equivalent in battery life to two months at 25°C. Heat is an enemy of all lead acid batteries, FLA, GEL, and AGM alike and even small increases in temperature will have a major influence on battery life.

TROJAN L16RE-2V PERFORMANCE

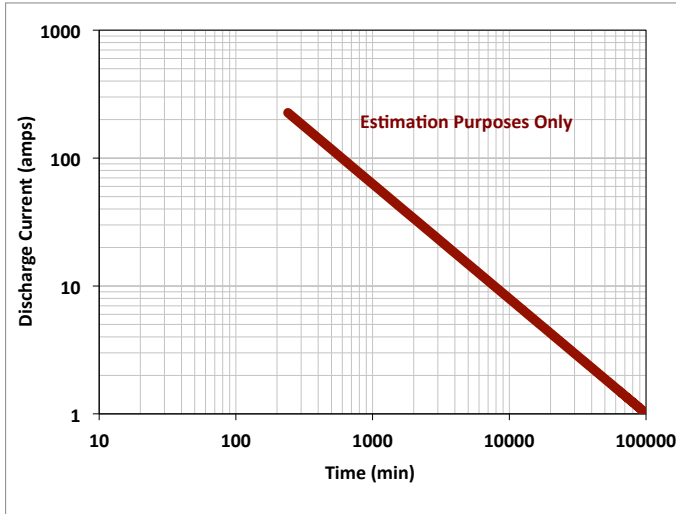

CYCLE LIFE

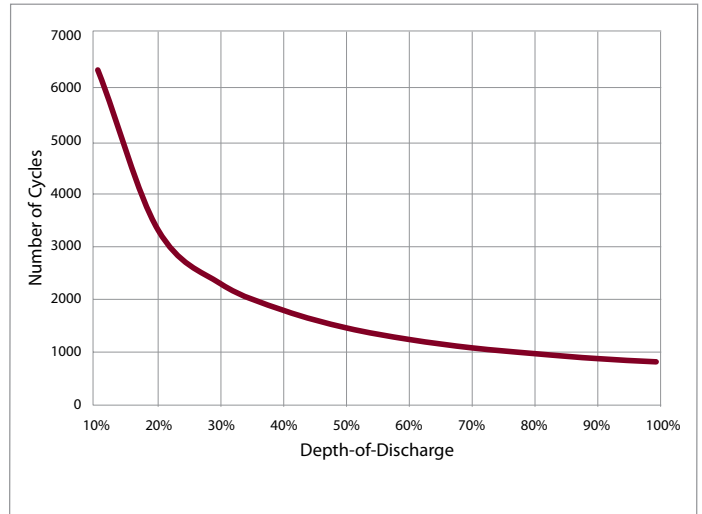

CAPACITY VS. TEMPERATURE

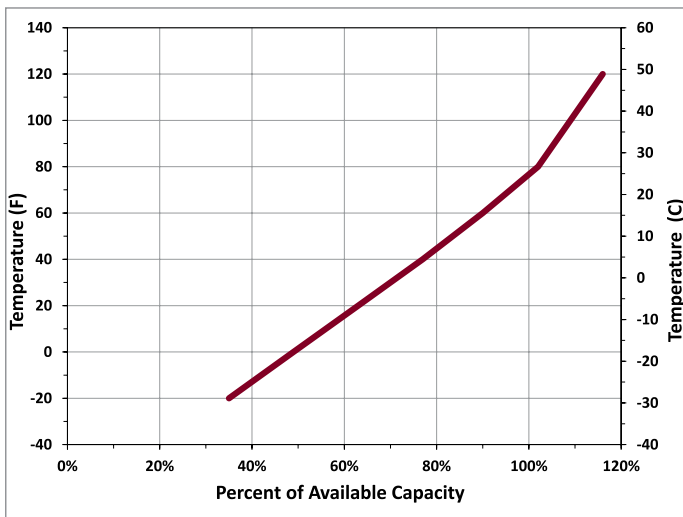

BATTERY DIMENSIONS

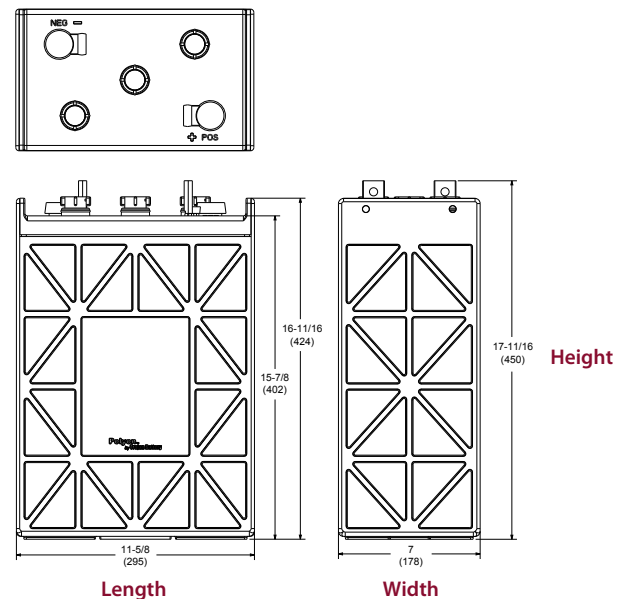

TERMINAL CONFIGURATIONS

5 LT L-Terminal



Terminal Height Inches (mm)
1-3/4 (43)

Torque Values in-lb (Nm)
100 - 120 (11 - 14)

Through-hole Diameter (mm)
3/8 (10)

VENT CAP



* Polyon™ Case

